

# **LUMEX<sup>®</sup>**

---

# **LUMEX AIR II**

# Low Air Loss Therapy Mattress Replacement System

Model # 763400A



# **Operators Manual**

**Please read the manual before use**

# Contents

Important Safeguards .....	2
Introduction .....	3
Product Description .....	4
Installation .....	5
Operation .....	7
Cleaning .....	10
Storage .....	11
Maintenance .....	11
Troubleshooting .....	12
Technical Description .....	13

# IMPORTANT SAFEGUARDS

## READ ALL INSTRUCTIONS BEFORE USING

### **DANGER - To reduce the risk of electrocution:**

1. Always unplug this product immediately after using.
2. Do not use while bathing.
3. Do not place or store product where it can fall or be pulled into a tub or sink.
4. Do not place in or drop into water or other liquid.
5. Do not reach for a product that has fallen into water. Unplug immediately.

### **WARNING - To reduce the risk of burns, electrocution, fire, or injury to persons:**

1. This product should never be left unattended when plugged in.
2. Close supervision is necessary when this product is used by, on, or near children or invalids.
3. Use this product only for its intended use as described in this manual. Do not use attachments not recommended by the manufacturer.
4. Never operate this product if it has a damaged cord or plug, if it is not working properly, if it has been dropped or damaged, or dropped into water. Return the product to a service center for examination and repair.
5. Keep the cord away from heated surfaces.
6. Never block the air openings of this product or place it on a soft surface, such as a bed or couch, where their openings may be blocked. Keep the air opening free of lint, hair, and other similar particles.
7. Never drop or insert any object into any opening or hose.
8. This device is class II equipment with functional earth, no Protective Earth id provided.  
(For 120V system only)

### **NOTE, CAUTION AND WARNING STATEMENTS:**

**NOTE-** Indicates some tips.

**CAUTION -** Indicates correct operating or maintenance procedures in order to prevent damage to or destruction of the equipment or other property.

**WARNING -** Calls attention to a potential danger that requires correct procedures or practices in order to prevent personal injury.

### **SYMBOLS**



"BF"symbol, indicates this product is according to the degree of protecting against electric shock for type BF equipment.



The Symbol for class II equipment, 2 concentric square indicating double insulation.



Attention, should read the instructions !

**IPX0** Enclosed equipment without protection against ingress of water.

**SAVE THIS MANUAL FOR REFERENCE**

# 1. Introduction

This manual should be used for initial set up of the system and for reference purposes.

## 1.1 General Information

LumexAir systems use most advanced technologies and mattress materials to deliver the best quality, comfort and whisper-quiet operations to you and your customers. Most systems in LumexAir are recommended for prevention and treatment of pressure ulcers up to and including stage IV pressure ulcers.

This LumexAir range of system has been independently tested and successfully approved to the following standards:

- EN60601-1 / UL 60601-1
- EN 60601-1-2
- IEC 61000-4-2
- IEC 61000-4-3
- IEC 61000-4-4
- IEC 61000-4-5
- IEC 61000-4-6
- IEC 61000-4-8
- IEC 61000-4-11
- EN55011 CLASS B
- EN 61000-3-2
- EN 61000-3-3

**⚠ FOR US AND CANADA ONLY**

E228589  
53DG



Medical Equipment-Air Pump

with respect to electrical shock, fire and mechanical hazards only in accordance with UL60601-1 and CAN/CSA C22.2 No. 601.1

## 1.2 Intended Use

The system is a true low air loss replacement system suitable for high-risk patients. It is non-alternating mattress designed with very low average pressure dispersion. The pulsation function on the compact pump unit provides patients the message action to stimulate the blood circulation and reduce the edema.

**⚠ NOTE : Equipment not suitable for use in the presence of a flammable anesthetic mixture with air or with oxygen or nitrous oxide.**

## 2. Product Description

### 2.1 Pump and Mattress System

The system consists of a high volume airflow blower and numerous large air loss holes on the mattress to achieve the true low air loss therapy. It also provides excellent ventilation and keeps patients dry from humidity. The 10 inch high mattress, which consists of 8 inch high air bladders at the top and a layer of 2" foam at the bottom, provide maximum comfort for patients. The 2" foam also functions as the emergency pressure dispersion in case of power failure. The air tube connector also operates as CPR facility can deflate the mattress within the shortest amount of time for emergency situation.

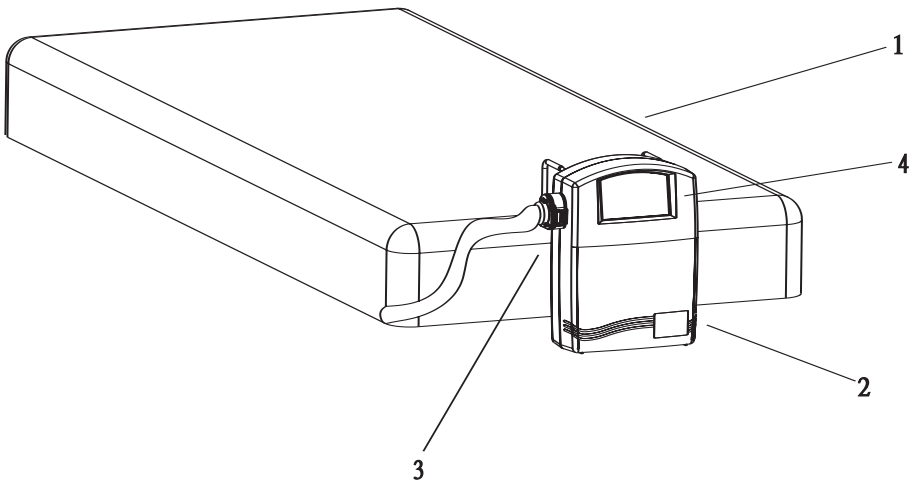

1. Mattress
2. Pump unit
3. Air tube connector
4. Control Panel

## 3. Installation

### 3.1 Unpacking

The pump unit and mattress are packaged in a separate box to secure its contents inside. Unpacking these boxes to remove the pump unit and mattress and check for any damage, which may have occurred in shipping. If there are damages, please contact your dealer immediately.

### 3.2 Setting Up

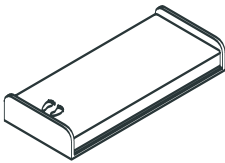

1. Place the mattress on top of the bed frame. Please note for the foot end. Mattress can be secured firmly by fixing the elastic straps at the bottom bed frame.

**⚠ NOTE: Please cover the mattress with a cotton sheet to avoid direct skin contact and for patient's comfort.**

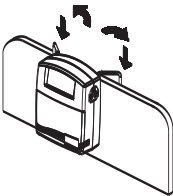

2. Hang the pump onto bed rail (foot-end), and adjust a suitable wideness of hangers.

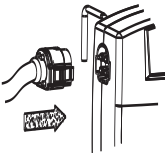

3. Connect air tube connector from air mattress to the pump unit. When "click" is felt or heard, the connection is completed and secured.

**⚠ NOTE: Check and ensure the air tubes are not kinked or tucked under mattress.**

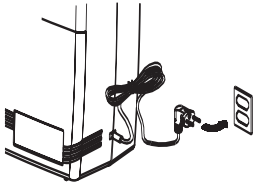

4. Plug into main electrical outlet.

**⚠ NOTE**

1. Make sure the pump unit is suitable for the local power voltage.
2. The plug also serves as the disconnect device

**⚠ CAUTION: The pump can only be applied to the mattress recommended by the manufacturer. Do not use it for any other purpose.**

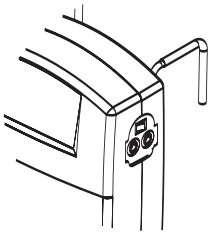

5 Then turn the main power switch ON. The power switch is located on the right side panel of the pump unit.

**⚠ NOTE: Ensure the CPR connectors are sealed completely.**





**Installation tips are listed below:**

After installation, the extra wire of the power cord, if any, should be neatly arranged to avoid any tripping accidents. The equipment should be firmly placed at position where users/doctors can access easily.





## 4. Operation

⚠ **NOTE:** Always read the operating instructions before use.

### 4.1 Function Description:

Control Button	Function Description
	<p><b>POWER</b> Two conditions:</p> <ol style="list-style-type: none"><li>1. To turn on control unit. It takes approximately 1 minute to inflate the mattress. The default setting is at a comfort range, level 6, for the quickest inflation time.</li><li>2. To turn off Power Failure Alarm in the event of a sudden power outage during normal use.</li></ol>
	<p><b>ALARM MUTE</b> Enable and disable the audible alarm feature. Press this button to silence the audible alarm. The alarm buzzer will sound again after 3 minutes if the pressure has not yet returned to the normal condition.</p>
	<p><b>PANEL LOCK</b> To lock the current setting and prevent others from changing. To unlock the panel, press this button and hold it for 3 seconds.</p>
	<p><b>LOW PRESSURE INDICATOR</b> 3 Conditions</p> <ol style="list-style-type: none"><li>1. No light - normal condition; mattress is operating properly.</li><li>2. Yellow light - pressure has not reached the preset setting.</li><li>3. Flashing yellow light - low pressure condition.</li></ol>



Control Button	Function Description
	<p><b>AUTOFIRM</b> For maximum inflation of mattress. All other functions are disabled unless this button is pressed again. This mode will last for 20 minutes and then it will return to default setting automatically.</p>
	<p><b>STATIC</b> For true low air-loss therapy mode, similar to a regular air mattress with very low air pressure support and true low air-loss therapy.</p>
	<p><b>PULSATION</b> For pulsating and true low air-loss therapy mode, it inflates and deflates the mattress between two comfort levels at 2 cycles per minute.</p>
	<p><b>COMFORT RANGE</b> The mattress has 6 comfort ranges. Use UP/DOWN button to adjust the comfort levels. 1 is the softest &amp; 6 is the firmest.</p>

## 4.2 Operating Instruction

1. Press the POWER button on the display panel to start the system.
2. For faster inflation, the AUTOFIRM function can be activated. This mode will last for 20 minutes and then it will return to default setting automatically.
3. After the mattress is fully inflated, user can change the setting according to their preference or recommended by physician.

## 4.3 CPR

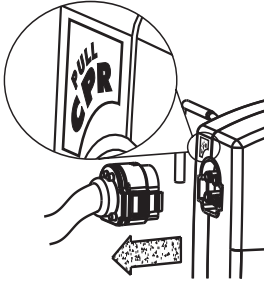

When there is an emergency to perform CPR on the patient, quickly pull the CPR valves to release air from mattress. The CPR valves are located at the head-end, right-hand-side of the mattress. The air hose on the pump unit can be disconnected for even faster deflation.

## 4.4 Comfort Range Setup

Users can adjust the pressure of air mattress by adjusting the comfort range from level 1 to 6.

Please consult your physician for a suitable setting.

When the Low Pressure Indicator is off, it indicates the mattress has reached to its preset softness. Patient can lie on the mattress.

**△ NOTE: Check to see if the suitable comfort range (or pressure setting) is selected by sliding one hand between the air cell and the patient to feel the patient buttock.**

**Users should be able to feel the minimal contact.**

## 4.5 Pulsation Function

The mattress will inflate to the preset pressure level and deflate to the next lower pressure level on a cycle of 2 times per minute. This means a 30 second period for one inflating and deflating cycle.

For example, if the Pulsation function is activated and the preset comfort level is set at level 2, then the pressure setting will increase and decrease 2 times per minute between comfort level 2 and 1.

## 4.6 Low Pressure and Alarm Function

When an abnormal low pressure occurs for a long time, the Low Pressure Indicator (flashing yellow LED) will light up with audible alarm. Check if all the connections are securely made and that they are correctly installed as per installation instructions.

**NOTE: If the pressure level is consistently low, check for any leakage at air cells or connecting tubes. If necessary, replace any damaged cells or tubes or contact local qualified dealer for repair.**

If the control unit is equipped without audible alarm feature, the Low Pressure Indicator will flash until the low-pressure fault condition is solved. If the control unit is equipped with audible alarm feature, the Low Pressure indicator will flash and the alarm will sound when air pressure is below normal (preset pressure). To silence the alarm, simply press the alarm mute button, and it will be silent for 3 minutes; however, the Low Pressure Indicator still remains flashing. After 3 minutes, alarm buzzer will alert again if the pressure has not yet returned to normal.

## **4.7 Power Failure Alarm**

If the pump unit has a sudden power outage during normal use, the power indicator LED on the control panel will flash " yellow" light, and alarm will sound. To silence the alarm, simply press Power button on the control panel.

When power failure situation occurs, alarm will last until backup battery is low or it can be turned off by manual operation.

Once power failure alarm situation is resolved, it is recommended to turn "OFF" the main power switch located at the lateral side of the pump. If the main power switch is not turned "OFF", once the main power comes back again, the pump will start again at "Standby" status.

## **5. Cleaning**

**⚠ CAUTION: Ensure the pump unit is disconnected from the main power before cleaning.**

### **5.1 Pump Unit**

Wipe with a damp cloth and a mild detergent and keep it away from dust. If other detergent is used, choose one that will have no chemical effects on the surface of the plastic case of the pump unit. All parts should be air dried thoroughly before use.

**⚠ CAUTION: Do not immerse or soak pump unit.**

### **5.2 Mattress**

Do not use Phenolic based products for cleaning.

For suitable and locally available cleaner please ask your distributor.

Wipe down with warm water containing a mild detergent. The cover may also be cleaned using sodium hypochlorite diluted in water. All parts should be air dried thoroughly before use.

**⚠ CAUTION: Dry the mattress on sunless area after cleaning.**

## 6. Storage

1. Pull the CPR tags and make sure all cells are deflated.
2. Lay the mattress out flat and upside down.
3. Protect the air tube coupler by putting it in the inner side of mattress.
4. Roll the mattress from the head end towards the foot end.
5. Foot-end straps can then be stretched around the rolled mattress to prevent unrolling.

## 7. Maintenance

### 7.1 General

1. Check main power cord and plug if there is abrasions or excessive wear.
2. Check mattress' cover for signs of wear or damage. Ensure mattress cover and tubes are stubbed together correctly.
3. Check the air tube connections for any damage.
4. Report any problems or malfunctions to local distributors.

### 7.2 Air Filter Replacement

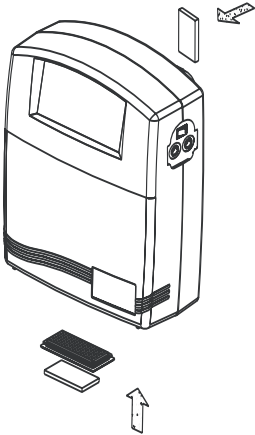

The air filter should be checked and dusted periodically once per month.

1. Two foam type filters are used. One is located on the back of pump and the other one is at the bottom of the Pump.
2. The filter is reusable and can be washed gently with a mild detergent and water.
3. Suggest to replace air filter regularly if the environment is dirty. This will help to improve the airflow. Spare filters are available from your local distributor.

### 7.3 Fuse Replacement

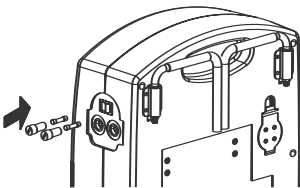

1. Disconnect the plug from main power when a fuse is to be replaced.
2. Remove the cover of the fuse holder by means of a small screwdriver.
3. Insert a new fuse of the correct rating in, and replace the cover of the fuse holder back. Check the technical specification for correct fuse rating.

## 8. Troubleshooting

Problem	Solution
Power is not ON	<ul style="list-style-type: none"> <li>• Check if the plug is connected to main power.</li> <li>• Check if there is any blown fuse.</li> </ul>
Alarm is on (audible & visual)	<ul style="list-style-type: none"> <li>• Check if the connection between air tube connector to pump unit is tightly secured.</li> <li>• Check if the CPR is sealed.</li> <li>• Check if there are any leakage on air cells.</li> <li>• Check if all tubing connections along mattress are secured.</li> </ul>
Patient is bottoming out	<ul style="list-style-type: none"> <li>• Pressure setting might be inadequate for the patient, adjust comfort range 1 to 2 levels higher and wait for a few minutes.</li> </ul>
Mattress becomes too firm and pressure can't be reduced.	<ul style="list-style-type: none"> <li>• This may happen when the AUTOFIRM is activated for too long. Release some air by disconnecting the air tube connector and change to preferred setting.</li> </ul>
Air Mattress is loose	<ul style="list-style-type: none"> <li>• Check if all the snap buttons or straps of mattress are all securely fastened.</li> <li>• Check if the mattress is fixed to the bed frame by elastic straps.</li> </ul>
Air tube connector won't fit into the pump unit	<ul style="list-style-type: none"> <li>• Press handles on both sides of air tube connector slightly before pushing the connector into the pump unit.</li> <li>• Make sure the connector is tightly secured by hearing "click" while pushing it into pump unit.</li> </ul>
Large airflow from air bladders	<ul style="list-style-type: none"> <li>• This is normal since this system has high airflow and numerous air loss holes on all bladders.</li> </ul>

If your questions can't be answered with above information, it might require a technician to take care the problem. Please contact your local dealer directly.

## 9. Technical Description

### Specifications:

Pump		Specification
Power Supply (Note: See rating label on the product)		120V AC 60Hz, 1A (For 120V system) 230VAC 50Hz, 7W ( For 230V system)
Fuse Rating		5A (For 120V system), T3A ( For 230V system)
Dimension		37 x 27 x 13 (cm) or 14.4" x 10.5" x 5"
Weight		4.5 kg or 9.9 lb
Environment	Temperature	Operation: 10° C to 40° C (50° F to 104° F) Storage: -10° C to 50° C (14° F to 122° F) Shipping: -10° C to 70° C (14° F to 158° F)
	Humidity	Operation: 30% to 75% non-condensing Storage: 10% to 90% non-condensing Shipping: 10 % to 90 % non-densing
	Atmosphere	700 hPa to 1060 hPa
Classification		<ul style="list-style-type: none"> <li>• Class II, Type BF, IPX0</li> <li>• Applied part: Air Mattress</li> <li>• Not suitable for use in the presence of a flammable anesthetic mixture (No AP or APG protection)</li> <li>• Continuous operation</li> </ul>
Mattress		Specification
Dimension (LxWxH)		2.. x 90 x 20.3 (cm) or 78.7" x 35.4" x 8"
Weight *		7 kg or 15.4 lb

\* The weight and dimension of mattress is measured without foam.

Consult the distributor or EU representative for further technical documents.

**NOTE: The specifications, also apply to those areas operating with the same power supply.**

**U.S.A., Corporate Headquarters:**

**Graham-Field Health Products**

2935 Northeast Parkway

Atlanta, Georgia 30360

telephone: 800-347-5678, 770-447-1609

fax: 800-726-0601, 678-291-3232



<http://www.grahamfield.com>